



© Jaguar Land Rover Limited
 All rights reserved.

This bulletin supersedes TSB L8890bu/2004 dated 02 OCT 2004, which should either be destroyed or clearly marked to show it is no longer valid (e.g. with a line across the page). Only refer to the electronic version of this Technical Bulletin in TOPIx.
This bulletin supersedes TSB L8914bu/2004 dated 10 FEB 2004, which should either be destroyed or clearly marked to show it is no longer valid (e.g. with a line across the page). Only refer to the electronic version of this Technical Bulletin in TOPIx.

SECTION: 206-09 (70 - Brakes)

Discovery II - LHD ABS Overlay Harness

AFFECTED VEHICLE RANGE:

Discovery Series II (LT) - VIN: XA200000-4A870624
Left-hand drive vehicles only

MARKETS:

All

CONDITION SUMMARY:

Situation:

Introduction of new anti-lock braking (ABS) sensor overlay harness - left-hand drive vehicles. This harness deletes the front connectors located on the inner wing/fenders and bypasses the rear harness connector located at the front bulkhead.

This new ABS overlay harness has been made available for service. The harness MUST be used instead of renewing the main harness for ABS sensor harness concerns (e.g. open circuit).

Should a concern with the front ABS sensor harness exist, follow the appropriate rectification procedure detailed in this bulletin to install a new ABS sensor overlay harness.

PARTS:

SSW500020	Service Sensor kit - Front	Quantity: 1
SSW500030	Service Sensor kit - Rear	Quantity: 1

WARRANTY:

 **NOTE: Repair procedures are under constant review, and therefore times are subject to change; those quoted here must be taken as guidance only. Always refer to TOPIx to obtain the latest repair time.**

 **NOTE: DDW requires the use of causal part numbers. Labor only claims must show the causal part number with a quantity of zero.**

 **NOTE: Repair procedures are under constant review, and therefore times are subject to change; those quoted here must be taken as guidance only. Always refer to DDW to obtain the latest repair time.**

DESCRIPTION	SRO	TIME	CONDITION CODE	CAUSAL PART
Renew ABS sensor and lead - front - RIGHT-HAND	70.65.89/41	2.10 hours	79	SSW500020
Renew ABS sensor and lead - front - LEFT-HAND	70.65.89/42	2.20 hours		
Renew ABS sensor and lead - rear - RIGHT-HAND	70.65.89/43	2.20 hours		
Renew ABS sensor and lead - rear - LEFT-		2.30		



NOTE: Normal Warranty procedures apply.

SERVICE PROCEDURE:

Left-hand drive vehicles only

Right-Hand Front ABS Sensor/Harness - Renew

1 Disconnect the battery ground lead. For additional information, refer to Discovery Series II Workshop Manual Section CHARGING AND STARTING, Battery (86.15.01).

If a fuel burning heater (FBH) is installed carry out steps **2** to **5** for removal, otherwise continue from step **6**.

2 Remove the nut securing the FBH exhaust pipe clip to the rubber mounting.

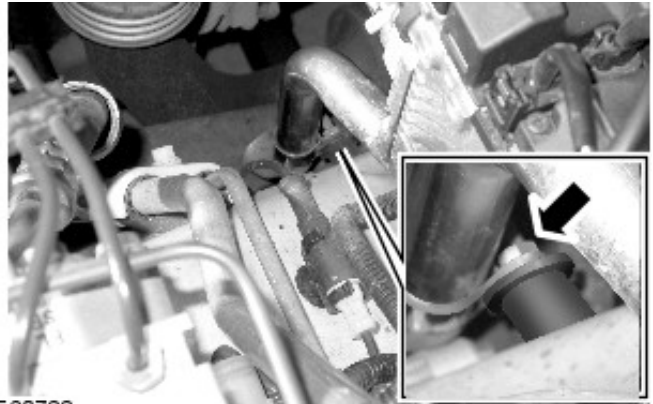

E60722

3 Release the exhaust pipe clip from the rubber mounting.

4 Remove the Torx bolt securing the FBH to the bulkhead mounting bracket.

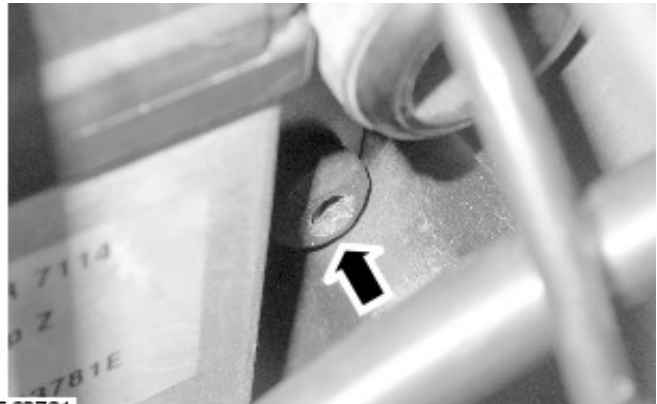

E60721

5 Release the FBH from the mounting bracket and move aside for access.

6 Disconnect the white ABS connector at the right-hand suspension turret.

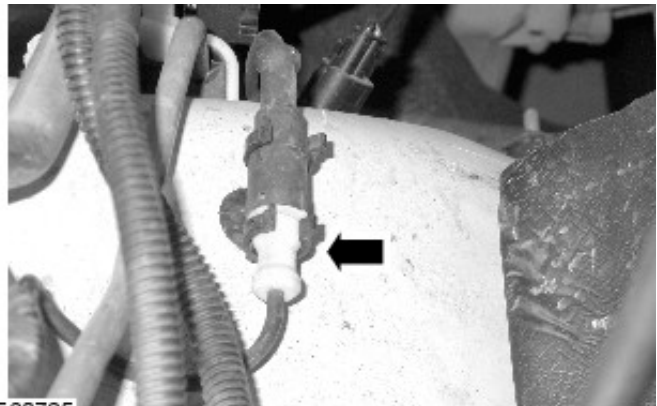

E60725

7 Release ABS sensor grommet and harness from inner wing.

8 Withdraw the harness through the aperture into the wheelarch.

9 Remove the right-hand front wheel.

10 Release the harness from the brackets on the

inner fender valance, suspension turret and front hub.

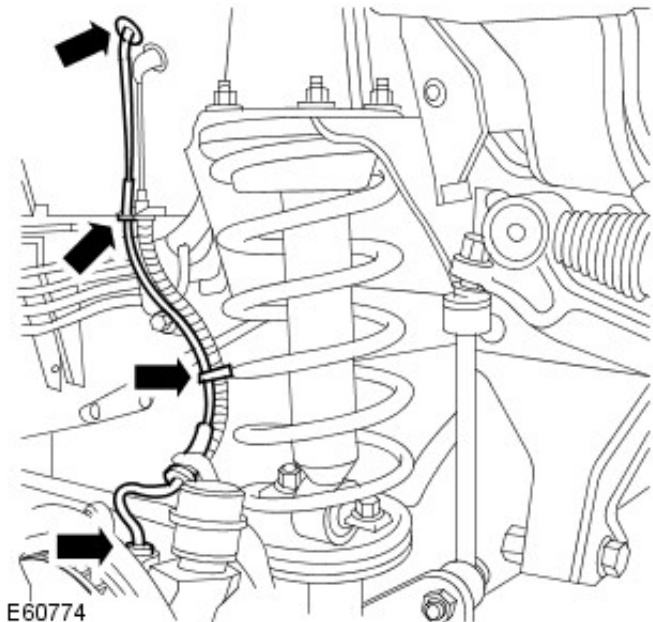

11 Remove the brake disc. For additional information, refer to Discovery Series II Workshop Manual Section BRAKES, Brake disc - front (70.12.10).

12 Loosen the four bolts securing the front hub to the swivel hub.

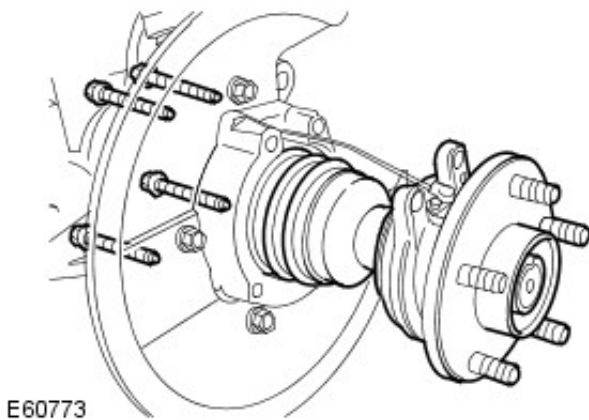

13  **CAUTION: Ensure that the general area is clean and dry to avoid dirt ingress into the joint between the front hub and swivel hub.**

Release the front hub from the swivel hub sufficiently to allow the sensor harness to be removed.

14  **CAUTION: Ensure the area around the ABS sensor is clean and dry to avoid dirt ingress into the front hub.**

Remove the Allen screw and release the ABS sensor from the front hub assembly.

15 Discard the 'O' ring seal.

16 Apply anti-seize grease to sensor.

17 Lubricate and install a new 'O' ring seal.

18  **CAUTION: Ensure the mating faces of the hub and new ABS sensor are clean.**

Position the ABS sensor between the hub and the swivel hub and tighten the Allen screw to 18 Nm (13 lbf.ft).

19 Position the hub and tighten the bolts to 100 Nm (74 lbf.ft).

20 Secure the ABS harness to the brackets and secure the grommet to the inner fender valance.

21 Install brake disc.

22 Install road wheel and tighten nuts to 140 Nm (103 lb-ft).

23 Remove the passenger-side footwell closing panel.

24 Remove the A-pillar lower finisher.

25 From inside the vehicle (passenger side), carefully reposition the carpet/NVH cover from the bulkhead to expose the bulkhead grommet.

26 From the engine bay, carefully pull the NVH cover away from the bulkhead and remove the grommet.

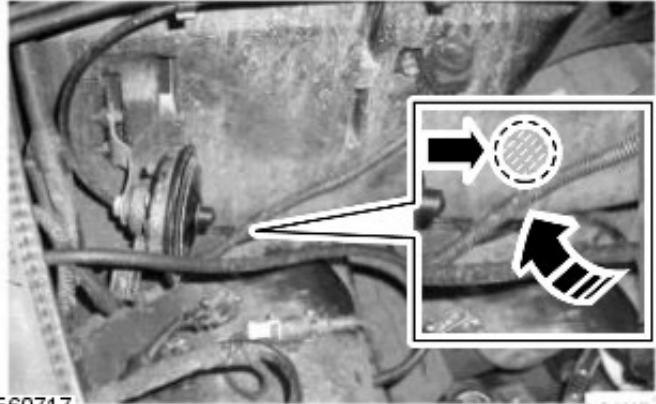

E60717

27 Make an incision in the center of the grommet and pass the new ABS harness through the grommet.

28 Pass the new harness through the bulkhead and install the grommet.

29 Secure the harness using cable ties where necessary and route the harness to the self-leveling and anti-lock braking (SLABS) electronic control unit (ECU). For additional information, refer to Discovery Series II Workshop Manual Section BRAKES, ECU - Self levelling and anti locking brakes (SLABS) (70.65.01).

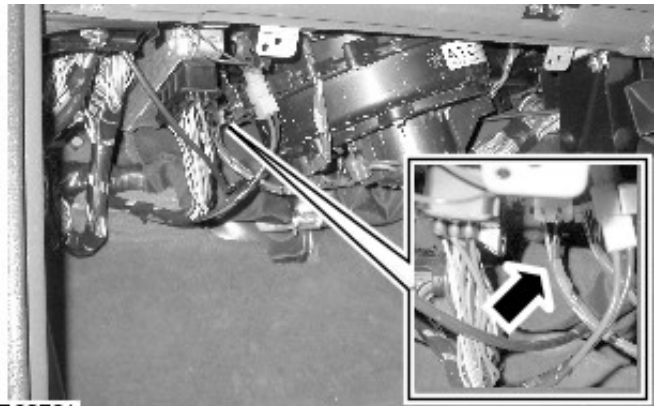

E60731

30 Cut away any excess harness and carefully remove approximately 50mm of outer insulation.

31 Strip the wire insulation to expose the wires conductors.

32 Install the crimp terminals supplied in the repair kit.

33 Disconnect connector C0505 from the SL/ABS ECU. For additional information, refer to Discovery Series II Electrical Library Workshop Manual Section Connectors, Connector Views (C0505).

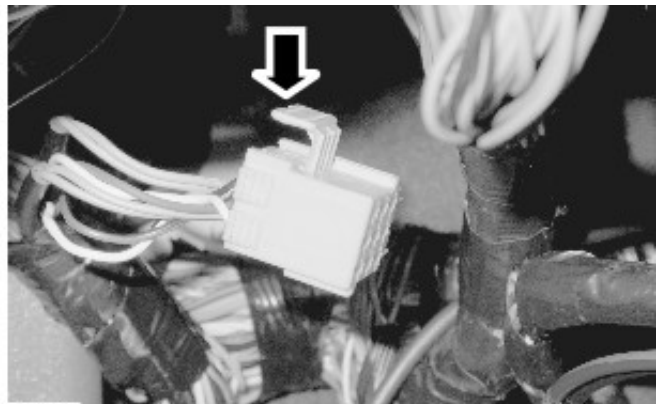

E60719

34  **CAUTION: This step refers to connector termination for the RIGHT-HAND FRONT SENSOR - LEFT-HAND DRIVE VEHICLES ONLY. Release the specified terminals only.**



NOTE: The new harness terminals may be connected in either cavity of the connector. They are not polarity sensitive.

Release terminals **four and five** from the connector and insert the new terminals.

35 Cut off the removed redundant terminals and secure back to the main harness using a suitable electrical tape.

36 Connect the SLABS connector.

37 Install the passenger-side footwell closing panel.

38 Install the A-pillar lower finisher.

If a fuel burning heater (FBH) is installed carry out steps from [39](#) for installation, otherwise continue from step [41](#).

39 Align the FBH to the mounting bracket and install the Torx bolt. Tighten to 25 Nm (18 lb-ft).

40 Locate the FBH exhaust pipe clip to the rubber mounting, install the nut and tighten to 6 Nm (4 lb-ft).

41 Connect the battery ground lead. For additional information, refer to Discovery Series II Workshop Manual Section CHARGING AND STARTING, Battery (86.15.01).

42 Using T4:

1. Clear the fault codes from SLABS ECU.
2. Raise the RHF corner of the vehicle.
3. Select the T4 overview screen.
4. With ignition at position two, spin the RHF wheel and check the input from the sensor is operating correctly.

43 Disconnect T4 and lower the vehicle.

44 Road test the vehicle.

SERVICE PROCEDURE:

Left-hand drive vehicles only

Left-Hand Front ABS Sensor/Harness - Renew

1 Disconnect the battery ground lead. For additional information, refer to Discovery Series II Workshop Manual Section CHARGING AND STARTING, Battery (86.15.01).

2 Disconnect the white ABS connector at the left-hand bulkhead.

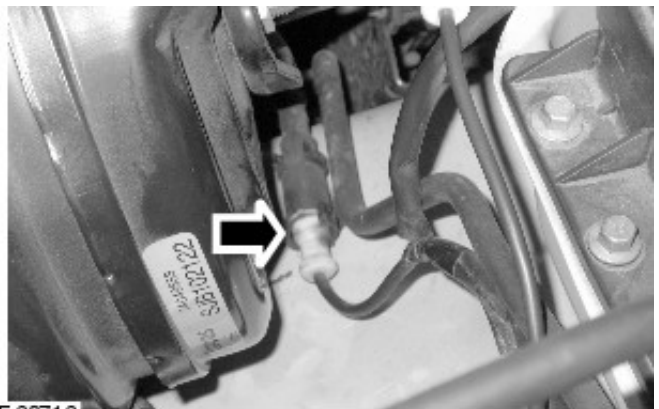

3 Release ABS sensor grommet and harness from inner wing.

4 Withdraw the harness through the aperture into the wheelarch.

5 Remove the left-hand front wheel.

6 Release the harness from the brackets on the inner fender valance, suspension turret and front hub.

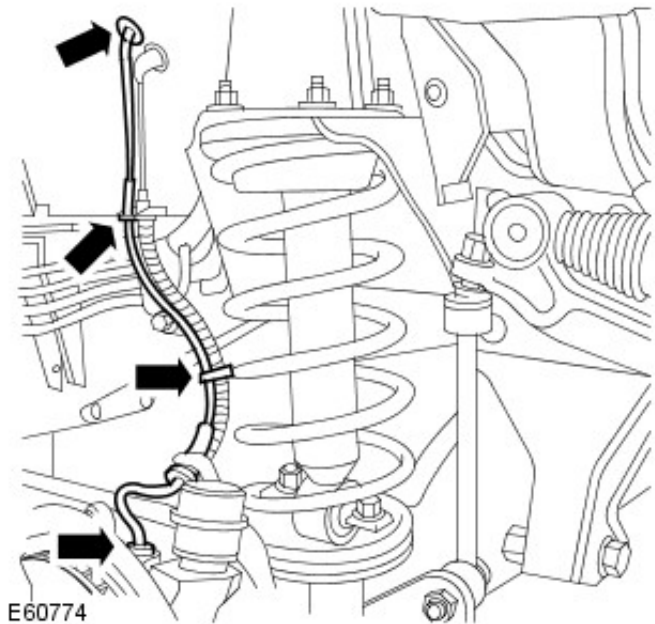

E60774

7 Remove the brake disc. For additional information, refer to Discovery Series II Workshop Manual Section BRAKES, Brake disc - front (70.12.10).

8 Loosen the four bolts securing the front hub to the swivel hub.

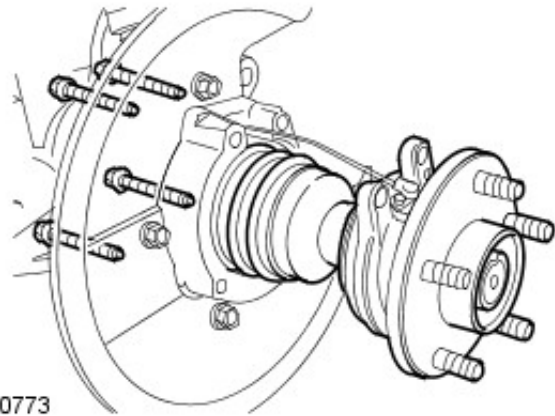

E60773

9  **CAUTION: Ensure that the general area is clean and dry to avoid dirt ingress into the joint between the front hub and swivel hub.**

Release the front hub from the swivel hub sufficiently to allow the sensor harness to be removed.

10  **CAUTION: Ensure the area around the ABS sensor is clean and dry to avoid dirt ingress into the front hub.**

Remove the Allen screw and release the ABS sensor from the front hub assembly.

11 Discard the 'O' ring seal.

12 Apply anti-seize grease to sensor.

13 Lubricate and install a new 'O' ring seal.

14  **CAUTION: Ensure the mating faces of the hub and new ABS sensor are clean.**

Position the ABS sensor between the hub and the swivel hub and tighten the Allen screw to 18 Nm (13 lbf.ft).

15 Position the hub and tighten the bolts to 100 Nm (74 lbf.ft).

16 Secure the ABS harness to the brackets and secure the grommet to the inner fender valence.

17 Install brake disc.

18 Install road wheel and tighten nuts to 140 Nm (103 lb-ft).

19 Release the driver-side footwell closing panel.

20 Remove the bulkhead grommet from under brake servo.

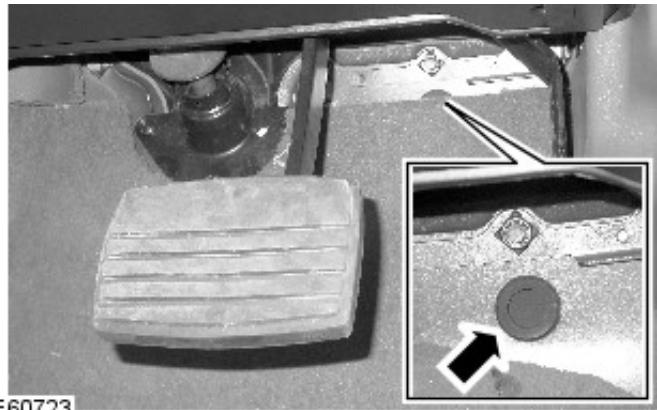

E60723

21 Make an incision in the center of the grommet and pass the new ABS harness through the grommet.

22 Pass the new harness through the bulkhead and install the grommet.

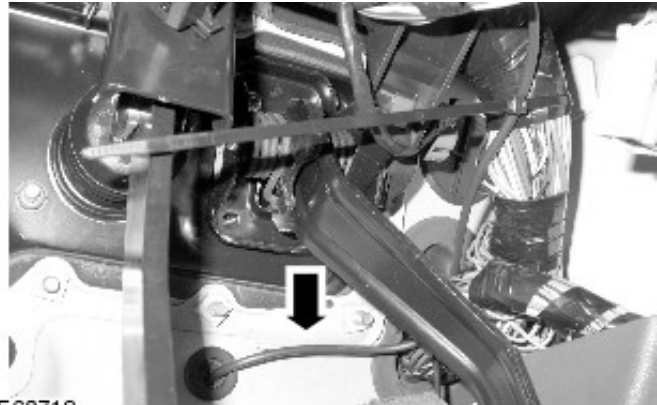

E60718

23 Secure the harness using cable ties where necessary and route the harness across the vehicle following the main wiring harness behind the center console to the self-leveling and anti-lock braking (SLABS) electronic control unit (ECU). For additional information, refer to Discovery Series II Workshop Manual Section BRAKES, ECU - Self levelling and anti locking brakes (SLABS) (70.65.01).

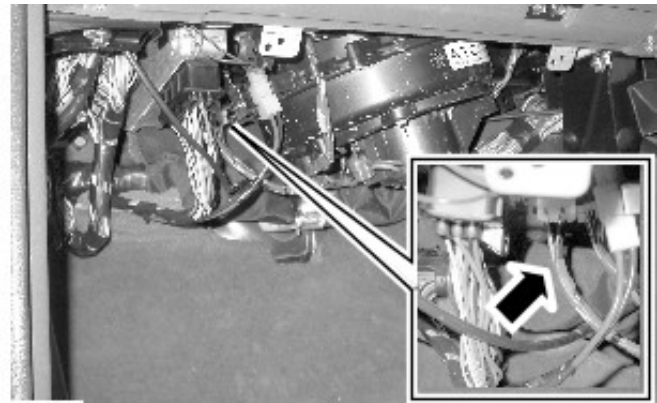

E60731

24 Cut away any excess harness and carefully remove approximately 50mm of outer insulation.

25 Strip the wire insulation to expose the wires conductors.

26 Install the crimp terminals supplied in the repair kit.

27 Disconnect connector C0505 from the SL/ABS ECU. For additional information, refer to Discovery Series II Electrical Library Workshop Manual Section Connectors, Connector Views (C0505).

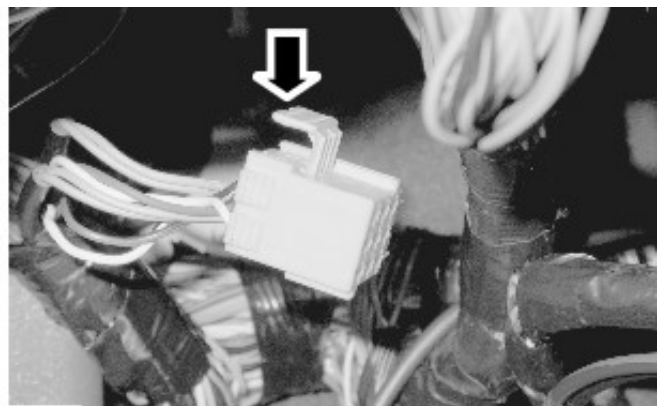

E60719

28  **CAUTION: This step refers to connector termination for the LEFT-HAND FRONT SENSOR - LEFT-HAND DRIVER VEHICLES ONLY. Release the specified terminals only.**



NOTE: The new harness terminals may be connected in either cavity of the connector. They are not polarity sensitive.

Release terminals **one and two** from the connector and insert the new terminals.

29Secure the removed redundant terminals back to the main harness using a suitable electrical tape.

30Connect the SLABS connector.

31Install the footwell closure panel.

32Connect the battery ground lead. For additional information, refer to Discovery Series II Workshop Manual Section CHARGING AND STARTING, Battery (86.15.01).

33Using T4:

1. Clear the fault codes from SLABS ECU.
2. Raise the LHF corner of the vehicle.
3. Select the T4 overview screen.
4. With ignition at position two, spin the RHF wheel and check the input from the sensor is operating correctly.

34Disconnect T4 and lower the vehicle.

35Road test the vehicle.

SERVICE PROCEDURE:

Left-Hand Drive Vehicles Only

Rear ABS Sensor/Harness - Renew

1Disconnect the battery ground lead. For additional information, refer to Discovery Series II Workshop Manual Section CHARGING AND STARTING, Battery (86.15.01).

2Remove the relevant rear wheel.

3Release the ABS sensor harness connector from the clip on the body and disconnect the connector.

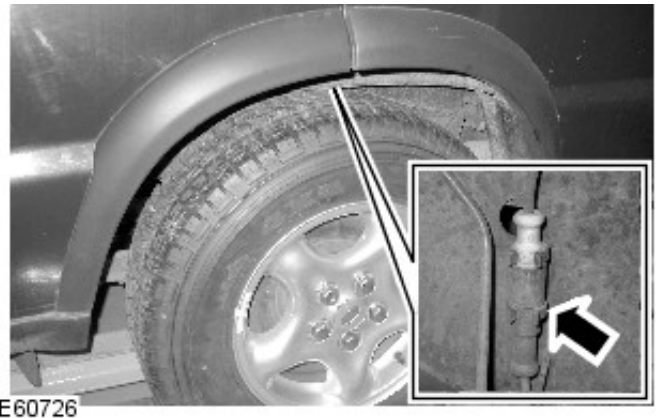

E60726



E60727

4Cut off the redundant ABS sensor connector lead back to the main harness and tape the exposed end to the main harness with insulating tape.

5Release the harness from the brake flexible hose and hose brackets.

6 Remove the brake disc. For additional information, refer to Discovery Series II Workshop Manual Section BRAKES, Brake disc - rear (70.12.33).

7 Remove the Allen screw and release the ABS sensor.

8 Discard the 'O' ring seal.

9 Apply anti-seize grease to sensor.

10 Lubricate and install a new 'O' ring seal.

11  **CAUTION: Ensure the mating faces of the hub and new ABS sensor are clean.**

Install the ABS sensor and tighten the Allen screw to 18 Nm (13Ibf.ft).

12 Install the harness into brake flexible hose clips on the brake hose.

13 Install the brake disc. For additional information, refer to Discovery Series II Workshop Manual Section BRAKES, Brake disc - rear (70.12.33).

14  **CAUTION: Do not secure the harness to brake or fuel lines.**

Secure the new ABS harness following the route of the main ABS harness to the front of the vehicle (passenger side bulkhead area).

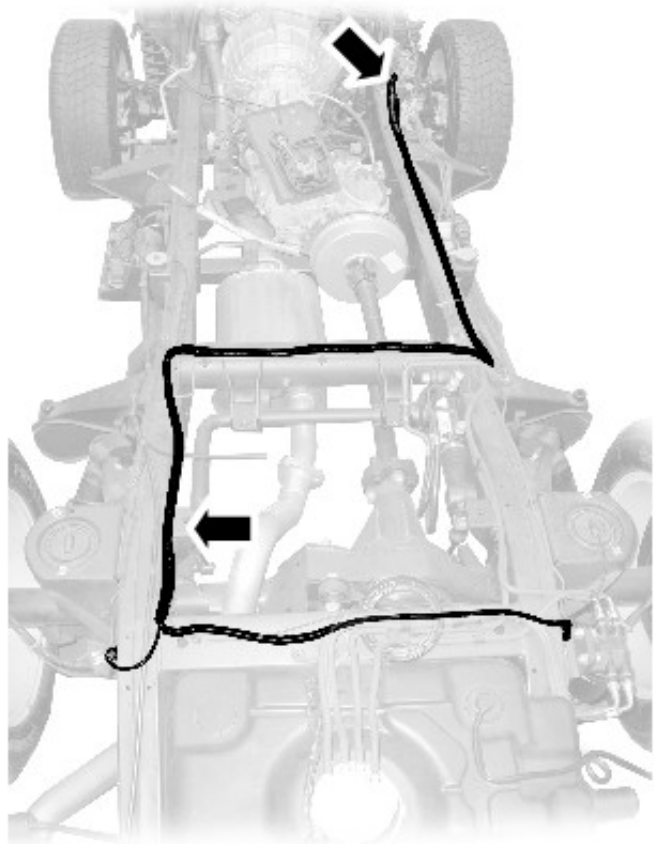

E60729

15 Install the road wheel and tighten nuts to 140 Nm (103 lb-ft).

16 Remove the passenger-side footwell closing panel.

17 Remove the driver-side footwell closing panel.

18 From inside the vehicle (passenger side), carefully reposition the carpet/NVH cover from the bulkhead to expose the bulkhead grommet.

19 From the engine bay, carefully pull the NVH cover away from the bulkhead and remove the grommet

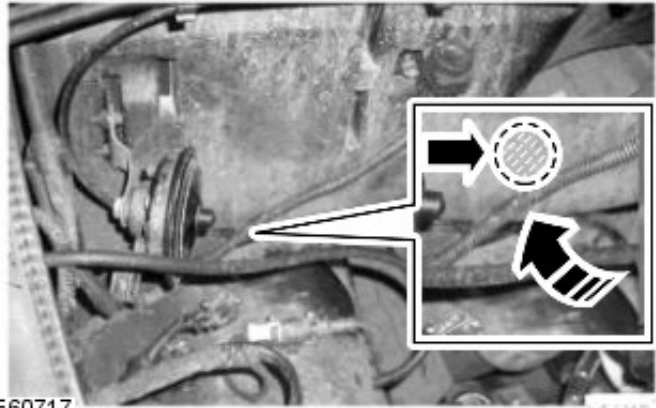

E60717

20 Make an incision in the center of the grommet and pass the new ABS harness through the grommet.

21 Pass the new harness through the bulkhead and install the grommet.

22 Secure the harness using cable ties where necessary and route the harness to the self-leveling and anti-lock braking (SLABS) electronic control unit (ECU). For additional information, refer to Discovery Series II Workshop Manual Section BRAKES, ECU - Self levelling and anti locking brakes (SLABS) (70.65.01).

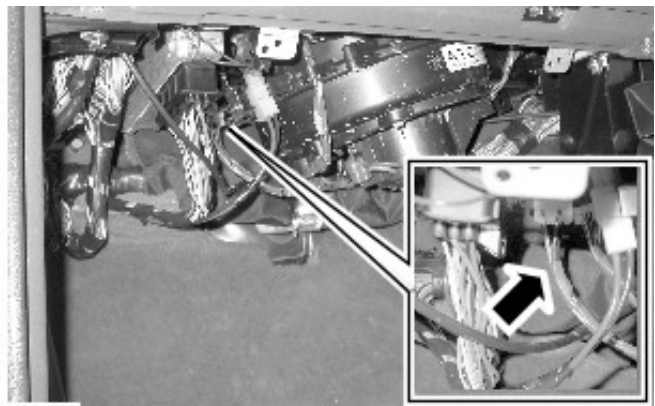

E60731

23 Cut away any excess harness and carefully remove approximately 50mm of outer insulation.

24 Strip the wire insulation to expose the wires conductors.

25 Install the crimp terminals supplied in the repair kit.

26 Disconnect connector C0505 from the SL/ABS ECU. For additional information, refer to Discovery Series II Electrical Library Workshop Manual Section Connectors, Connector Views (C0505).

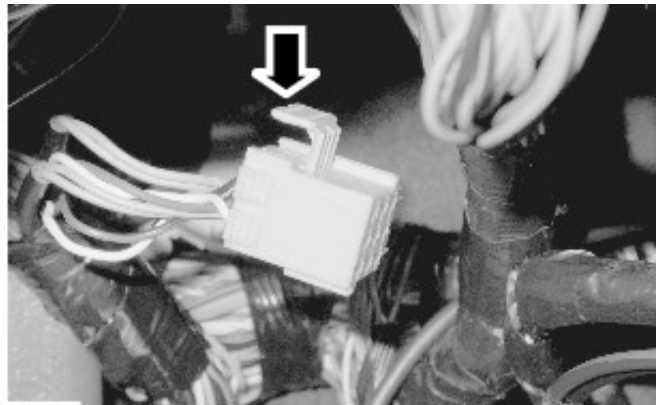

E60719

27  **CAUTION: This step refers to connector termination for LEFT HAND DRIVE vehicles ONLY. Release the specified terminals only.**



NOTE: The new harness terminals may be connected in either cavity of the connector. They are not polarity sensitive.

For the **left-hand rear** sensor, release terminals **seven and eight** from the connector and insert the new terminals.

For the **right-hand rear** sensor, release terminals **three and six** from the connector and insert the new terminals.

28 Cut off the removed redundant terminals and secure back to the main harness using a suitable electrical tape.

29 Connect the SLABS connector.

30 Install the footwell closure panels.

31 Connect the battery ground lead. For additional information, refer to Discovery Series II Workshop Manual Section CHARGING AND STARTING, Battery (86.15.01).

32 Using T4:

1. Clear the fault codes from SLABS ECU.
2. Raise the relevant corner of the vehicle.
3. Select the T4 overview screen.
4. With ignition at position two, spin the relevant rear wheel and check the input from the sensor is operating correctly.

33 Disconnect T4 and lower the vehicle.

34 Road test the vehicle.